



*Safe Keeper*

## USER INSTRUCTION MANUAL

# BEAM ANCHOR



THIS INSTRUCTION MANUAL  
APPLIES TO THE FOLLOWING MODEL:  
SA08-SK



ANSI Z359.18-2017

Please read and understand the manufacturer's instructions for each component or part of the complete system. Manufacturer's instructions must be followed for proper use, care, and maintenance of this product. These instructions must be retained and be kept available for the worker's reference at all times. Alterations or misuse of this product, or failure to follow instructions, may result in serious injury or death.

**Note:** The user is advised to keep this user instructions document for the life of the product.

<b>Manufacturer</b>	: SAFE KEEPER, 314 E. CANAL ST. MULBERRY, FL 33860
<b>Certification Body</b>	: SATRA Technology Centre, Wyndham Way, Telford Way, Kettering, NN16 8SD, UK (Notified Body 0321)

This manual must be read and understood in its entirety and used as part of fall protection training program as required by OSHA or any state regularity agency. These instructions are intended to meet the manufacturer instructions as required by ANSI Z359.18-2017 and OSHA . The user must fully understand the proper equipment use and limitations.

**TECHNICAL SPECIFICATIONS :**

Ref. No.	Product Name	Minimum Breaking System	Material of Construction	Complying Norm
SA08-SK	Beam Anchor	5000 lbs / 23 kN	Aluminium Alloy & Brass	ANSI Z359.18-2017 Type A

**1. GENERAL REQUIREMENTS, WARNINGS AND LIMITATIONS:**

- ☒ The Equipment is designed for use as a part of a personal fall protection system. Components must not be used for any other operation other than that which it has been designed and approved. Fall Arrest system are designed to comply with OSHA. Fall Restraint System must be designed by a Qualified Person, and must be installed and used under the supervision of a competent person.
- ☒ All authorized persons/users must refer the regulations governing occupational safety, as well as applicable ANSI or CSA standards. Please refer to product labeling for information on specific OSHA regulations, and ANSI and CSA standards met by product.
- ☒ Consult a doctor if there is any reason to doubt a user's ability to withstand and safely absorb fall arrest forces. Age, fitness, health conditions can seriously affect the worker in case a fall occurs. Pregnant Women and minors should not use this equipment.
- ☒ Proper precautions should always be taken to remove any obstructions, debris, material, or other recognized hazards from the work area that could cause injuries or interfere with the operation of the system. All equipment must be inspected before each use according to the manufacturer's instructions. All equipment should be inspected by a qualified person on a regular basis.
- ☒ All equipments must be regularly inspected by a competent person & must be checked before each use.
- ☒ To minimize the potential for accidental disengagement, a competent person must ensure system compatibility.
- ☒ Equipment must not be altered in any way. Repairs must be performed only by the Manufacturer, or persons entities authorized in writing by the manufacturer.
- ☒ Any product exhibiting deformities, unusual wear, or deterioration must be immediately discarded. Any equipment subject to a fall must be removed from service. The authorized person/user shall have a rescue plan and the means at hand to implement it when using this equipment.
- ☒ Never use fall protection equipment for purposes other than those for which it was designed. Fall protection equipment should never be used for towing or hoisting.
- ☒ All synthetic material must be protected from slag, hot sparks, open flames, or other heat sources. The use of heat resistant materials is recommended in these applications.
- ☒ Never use natural materials (manila, cotton, etc.) as part of a fall protection system.
- ☒ Do not expose this equipment to chemicals which may have a harmful effect on the materials used to construct it. Be especially aware of caustic environment, or those that contain high levels of organic acids or bases. If you are uncertain about the safe operation of this equipment in any environment, contact SAFEKEEPER for further instructions.
- ☒ Do not use the equipment near sharp edges, abrasive surfaces and looping around small diameter structural members.
- ☒ Do not use the equipment around moving machinery or electrical hazards.
- ☒ SAFEKEEPER Steel Anchors should be used only with the combinations of components, sub-systems or both which may affect or interfere with the safe function of one another. Be certain that connecting devices are compatible and that other elements of the PFAS are safe and compatible before use.
- ☒ Anchorage connector has been tested in compliance with the requirements of ANSI/ASSE Z359.7, and it must be understood that the ANSI compliance and testing covers only the hardware and does not extend to the anchorage and substrate to which the anchorage connector is attached.

- Anchorage connector shall only be connected to anchorages that:
  - Can withstand 5,000 pounds (22.2kN) without failure.
  - Are certified by a professional engineer as having the required strength for fall arrest.
  - Structures are duly checked and certified by a qualified person.
  - Anchorage connectors are certified to be used at a minimum temperature of -30°F (-34°C).
- Ensure to remove any surface contamination such as concrete, stucco, roofing material, etc., that could accelerate cutting or abrading of attached components.
- To be used by personnel weighing not more than 310lbs (including accessories).
- For installation of Anchor, Both Sheeting & purling should be present.
- Anchor must be installed away from edge at minimum 6.0 feet & maximum of 8.5 feet.
- Anchor should be installed on minimum 22 gauge metal sheeting over the 14 gauge Z purling minimum.

## 2. SYSTEM LIMITATIONS & REQUIREMENTS:

Consider the following limitations/requirements prior to installing or using this equipment:

- **Capacity:** SAFEKEEPER Steel Anchors are designed for use by ONE person with a combined weight (clothing, tools, etc.) of not more than 310 lbs. (140 kg) Make sure all of the components in the system are rated to a capacity appropriate to the application. All SAFEKEEPER Steel Anchors are rated 5000 lbs. (23 kN).
- **Free Fall:** Personal fall arrest systems used with this equipment must be rigged to limit the free fall to 6 feet (1.8 M) as per ANSI Z359.1. Restraint systems must be rigged so that no vertical free fall is possible. Work positioning systems must be rigged so that free fall is limited to 2 feet (.6 m) or less. Personnel riding systems must be rigged so that no vertical free fall is possible. Climbing systems must be rigged so that free fall is limited to 18 inch. (.46 cm) or less. Rescue systems must be rigged so that no vertical free fall is possible. See subsystem manufacturer's instructions for more information. Below figure illustrates fall clearance requirements. There must be sufficient clearance below the user to allow the system to arrest a fall before the user strikes the ground or other obstruction. Clearance required is dependent on the following factors:

- Elevation of Anchorage
- Connecting Subsystem Length
- Deceleration Distance
- Free Fall Distance
- Worker Height

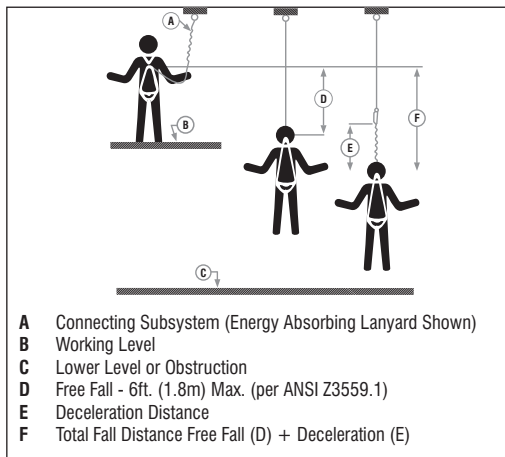

## 3. MOVEMENT OF HARNESS ATTACHMENT ELEMENT:

- **Swing Falls:** Swing falls occur when the anchorage point is not directly above the point when a fall occurs. The force of striking an object in a swing fall may cause serious injury or death. Minimize swing falls by working as close to the anchorage point as possible. Do not permit a swing fall if injury could occur. Swing falls will significantly increase the clearance required when a self-retracting lifeline or other variable length connecting subsystem is used.

## 4. ENVIRONMENTAL HAZARDS:

Use of this equipment in areas with environmental hazards may require additional precautions to prevent injury to the user or damage to the equipment. Hazards may include, but are not limited to; heat, chemicals, corrosive environments, high voltage power lines, gases, moving machinery and sharp edges.

## 5. COMPATIBILITY OF COMPONENTS:

Unless otherwise noted, SAFEKEEPER equipment is designed for use with SAFEKEEPER approved components and subsystems only. Substitutions or replacements made with non-approved components or subsystems may jeopardize compatibility of equipment and may affect safety and reliability of the complete system.

- **Compatibility of Connectors:** Connectors are considered to be compatible with connecting elements when they have been designed to work together in such a way that their sizes and shapes do not cause their gate mechanisms to inadvertently open regardless of how they become oriented. If the connecting element that a snap hook or karabiner attaches to is undersized or irregular in shape, a situation could occur where the connecting element applies a force to the gate of the snap hook or Karabiner. This force may cause the gate (of either a self-locking or a non-locking snap hook) to open, allowing the snap hook or Karabiner to disengage from the connecting point. Connectors must be compatible in size, shape, and strength. Self-locking snap hooks and Karabiners must comply to ANSI Z359.1 and OSHA.

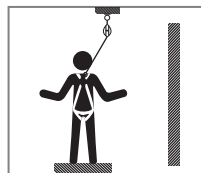

- ☒ **Making Connections:** Always use snap hooks and Karabiners which needs double manual action to open with this equipment. Only use connectors that are suitable to each application. Ensure all connections are compatible in size, shape and strength. Do not use equipment that is not compatible. Ensure all connectors are fully closed and locked the connection should not be made-
  - ☒ To a D-ring to which another connector is attached.
  - ☒ In a manner that would result in a load on the gate.
  - ☒ In a false engagement, where features that protrude from the snap hook or Karabiner catch on the anchor and with out visual confirmation seems to be fully engaged to the anchor point.
  - ☒ To each other.
  - ☒ Directly to webbing or rope lanyard or tie-back (unless the manufacturer's instructions for both the lanyard and connector specifically allow such a connection).
  - ☒ To any object which is shaped or dimensioned such that the snap hook or Karabiner will not close and lock, or that roll-out could occur.

**Note:** Other than 3,600 lb. (16 kN) gated hooks, large throat opening snap hooks should not be connected to standard size D-rings or similar objects which will result in a load on the gate if the hook or D-ring twists or rotates. Large throat snap hooks are designed for use on fixed structural elements such as rebar or cross members that are not shaped in a way that can capture the gate of the hook.

#### 6. RESTRICTIONS REGARDING MAKING CONNECTIONS:

- ☒ Do not make connections where the hook locking mechanism can come into contact with a structural member or other equipment and potentially release the hook.
- ☒ Do not connect a snap hook into a loop or thimble of a wire rope or attach in any way to a slack wire rope.
- ☒ The snap hook must be free to align with the applied load as intended (regardless of the size or shape of the mating connector)
- ☒ A karabiner may be used to connect to a single or pair of soft loops on a body support such as a body belt or full body harness, provided the karabiner can fully close and lock. This type of connection is not allowed for snap hooks.
- ☒ A karabiner may be connected to a loop or ring connector that is already occupied by an automatic closing connector.

If the connecting element that a snap hook (shown) or Karabiner attaches to is undersized or irregular in shape, a situation could occur where the connecting element applies a force to the gate of the snap hook or Karabiner. This force may cause the gate (of either a self-locking or a non-locking snap hook) to open, allowing the snap hook or Karabiner to disengage from the connecting point.

#### Unintentional Disengagement (Roll-Out)

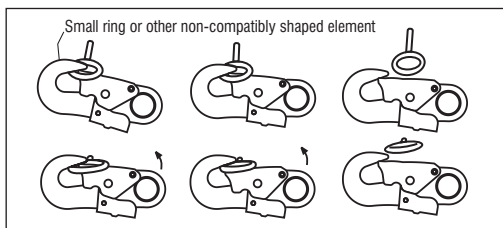

1. Force is applied to the snap hook.
2. The gate presses against the connecting Ring.
3. The gate opens allowing the snap hook to slip off.

#### Inappropriate Connections

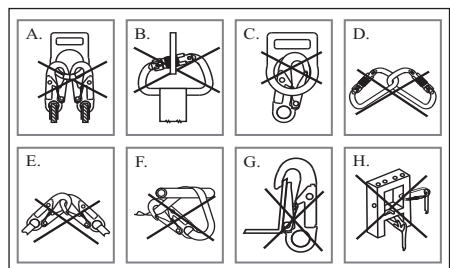

**7. CONNECTING SUB-SYSTEMS:**

Personal fall arrest systems used with this equipment must meet applicable state, OSHA and ANSI requirements. A full body harness must be worn when this equipment is used as a component of a personal fall arrest system. As required by OSHA, the personal fall arrest system must be capable of arresting the user's fall with a maximum arresting force of 1,800 lbs. (8 kN), and limit the free fall to 6 ft. (1.8 m) or less. If the maximum free fall distance must be exceeded, the employer must document, based on test data, that the maximum arresting force will not be exceeded, and the personal fall arrest system will function properly. Free fall greater than 6 ft. (1.8 m), and up to a maximum of 12 ft. (3.7 m) is possible, SAFEKEEPER recommends using a personal fall arrest system incorporating a SAFEKEEPER Energy Absorbing Lanyard. SAFEKEEPER has performed testing using the SAFEKEEPER Energy Absorbing Lanyard in free falls up to 12 ft. (3.7 m) to ensure the maximum arresting force does not exceed 1,800 lbs. (8.0 kN), and the system functions properly.

**8. RESCUE PLAN:**

Rescue operation must be performed by a trained and competent personnel. The rescue operation must be performed under the supervision of the rescue expert team or personal. It is advised that while working on site work in pairs. Before going for the work the user must have the rescue plan ready according to the work.

**If Equipment Is Subjected To A Fall:**

Remove the equipment from service immediately if it has been subjected to the forces of a fall arrest. Contact your distributor or SAFEKEEPER about policies regarding replacement of SAFEKEEPER components involved in a fall.

**9. SPECIFIC INSTRUCTIONS:**

SAFEKEEPER Anchors are designed to provide complete attachment system to the user in the event of a fall. These attachment systems must be connected to the proper body support and connecting facility. These Anchors are meant to hold the victim of fall till the rescue operation is performed, so this is important that the whole system must have all the essential components before going for use. The whole fall arrest system must be used by a trained/competent person. It is advisable to make a checklist of the essential components according to one's use before going for work.

**10. USE OF FALL ARREST SYSTEM:**

The fall arrest system MUST ONLY be connected to the back attaching element on the harness provided for the purpose ("D" ring or webbing attachment extension) or to the chest anchorage points ("webbing link" or "D" link). The chest anchorage points must imperatively be used together. The D-rings on the belt and the ventral anchorage point must only be used for the attachment of a work positioning or retaining system and never with a fall arrest system.

During use, check regularly the adjustment and/or attachment points.

**11. INSPECTION:**

Before each use, proceed with thorough visual examination to ensure that the PPE is intact (the same applies for the equipment used with the harness (connectors, lanyard...)) and take all necessary steps concerning the implementation of rescue in total safety. In the event of your product being contaminated, consult the manufacturer or authorized agent. If you have any doubts regarding the safe state of the product or if the product has been used to arrest a fall, for your personal safety, it is essential to withdraw the PPE from service and send it back to the manufacturer or a qualified repair Center for checking or destruction.

Following the inspection, the center will provide written authorization or refusal for the use of the PPE. Never attempt to modify or repair PPE.

Before each use of this equipment inspect it according to the following guidelines: A formal inspection of fall protection products/components must be performed at least every six months by a competent person other than the user. The frequency of formal inspections should be based on conditions of use or exposure. Record the inspection results in the inspection and maintenance log at the end of this manual. The component should be checked for Cut, Frayed, Heavily Soiled, Welding Burns etc. Metal parts like D-rings should be duly checked for cracks, bents, deformities, corruptions etc.

## 12. INSTRUCTIONS FOR INSTALLATION & USAGE OF FOLLOWING ANCHOR:

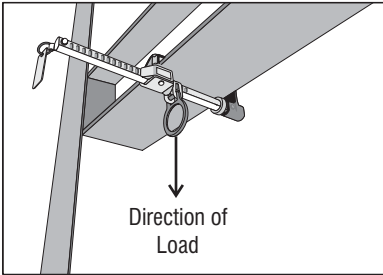
Instructions for Installation of Beam Anchor (SA08-SK)	
Beam anchor is intended to be installed on flanges of beam from 3.54" mm to 13.38" width.	
•	Push the latch and adjust the movable jaw enough to allow the clamping jaws to fit over the flange of beam and release the latch to lock its position.
•	Use the D-ring as connecting point.
	

**13. ANCHORAGE STRENGTH :** The Anchorage strength required depends on the application type. Following are the requirements of ANSI 359.1 for these application types:-

- **Anchorage & anchorage strength :** Anchorage and anchorage strength requirements are dependent on the full body harness application. In accordance with ANSI Z3559.1, anchorages selected for fall Arrest Systems must meet the anchorage strength requirements defined in below Table.

Table - Anchorage Strength Requirements		
Fall Arrest <sup>1</sup>	Non-Certified Anchorage:	5000 lbs. (23 kN)
	Certified Anchorage <sup>2</sup> :	2 Times the Maximum Arresting Force for Certified Anchorage
Restraint <sup>1</sup>	Non-Certified Anchorage	1,000 (4,5 kN)
	Certified Anchorages <sup>2</sup> :	2 times the foreseeable force for certified anchorages.
Work Positioning <sup>1</sup>	Non-Certified Anchorages	3,000 lbs (13.3 kN)
	Certified Anchorage <sup>2</sup> :	2 times the foreseeable force for certified anchorage.
Rescue <sup>1</sup>	Non-Certified Anchorage	3,000 lbs (13.3 kN)
	Certified Anchorage <sup>2</sup> :	5 times the foreseeable force for certified anchorage.
Climbing	The structure which a climbing system is attached must sustain the loads required by that particular system. See the instructions for the climbing system for requirements.	

- 1 Multiple Systems:** When more than one of the defined system is attached to an anchorage, the strength defined for Non-Certified or certified anchorage shall be multiplied by the number of systems attached to the anchorage.
- 2 Certified Anchorage:** An anchorage for fall arrest, positioning, restraint, or rescue systems that a qualified person certifies to be capable of supporting the potential fall force that meet the criteria for a certified anchorage prescribed in this standard.

- ✎ **Field Serviceability Testing** - It is not required and also not recommended to perform this testing by the End user.
- ✎ **Fall Arrest:** Anchorages selected for fall arrest systems shall have a strength capable of sustaining static loads applied in the directions permitted by the system of at least: 1. 5000 lbs. (23 kN) for non-certified anchorages, or 2. Two times the maximum arresting force for certified anchorages. When more than one fall arrest system is attached to an anchorage, the strengths set forth in (1) and (2) above shall be multiplied by the number of systems attached to the anchorage.
- ✎ **As Per OSHA:** Anchorages used for attachment of personal fall arrest systems shall be independent of any anchorage being used to support or suspend platforms and capable of supporting at least 5,000 lbs.(23 kN) per user attached, or be designed, installed and used as part of a complete PFAS which maintains a safety factor of at least two, and is under the supervision of a qualified person.
- ✎ **Work Positioning:** The structure to which the work positioning system is attached must sustain static loads applied in the directions permitted by the work positioning system of at least 3,000 lbs., or twice the potential impact load, whichever is greater. See OSHA. When more than one work positioning system is attached to an anchorage, the strengths stated above must be multiplied by the number of work positioning systems attached to the anchorage.
- ✎ **Restraint:** Anchorages selected for restraint and travel restraint systems shall have a strength capable of sustaining static loads applied in the directions permitted by the system of at least: 1. 1,000 lbs. (4.5 kN) for non-certified anchorages, or 2. Two times the foreseeable force for certified anchorages. When more than one restraint and travel restraint system is attached to an anchorage, the strengths set forth in (1) and (2) above shall be multiplied by the number of systems attached to the anchorage.
- ✎ **Rescue:** Anchorages selected for restraint and travel restraint systems shall have a strength capable of sustaining static loads applied in the directions permitted by the system of at least: 1. 3,000 lbs. (13.3 kN) for non-certified anchorages, or 2. Five times the foreseeable force for certified anchorages. When more than one restraint and travel restraint system is attached to an anchorage, the strengths set forth in (1) and (2) above shall be multiplied by the number of systems attached to the anchorage.
- ✎ **Fall clearance :** If there is a risk of fall or if the only anchorage is below the attachment points on the harness, it is essential to use a lanyard provided with an energy absorber. Before using a shock-absorbing lanyard, check that there is sufficient fall clearance below the user to prevent any collision with the structure or the ground.

#### 14. PERIODIC EXAMINATION:

Keep these instructions with the product and fill in the identification sheet, entering the information taken from the markings.

- ✎ The periodic examination is essential to test the resistance and condition of the equipment and to guarantee the safety of the user.
- ✎ A qualified person must examine this equipment at least once each year in strict compliance with the instructions of the manufacturer and the previous check must be recorded on the attached sheet.
- ✎ The frequency of inspection should be increased in accordance with the regulations, if the equipment is in heavy usage or if the equipment is used in harsh environments. Also Check that the markings are legible.

#### 15. MATERIAL OF CONSTRUCTION:

- ✎ **Material :** Please refer technical specification sheet.

#### 16. SYSTEM REQUIREMENTS:

- ✎ **Compatibility of Components:** SAFEKEEPER Fall Protection equipment is designed to be used with SAFEKEEPER approved components. Please contact SAFEKEEPER if you have a question regarding compatibility. Making substitutions without approval from SAFEKEEPER Fall Protection may lead to injuries and or death by compromising the safety and reliability of the complete system. A Qualified person can make a determination on compatibility of equipment from different manufacturers.
- ✎ **Compatibility of Connectors:** Connectors (D-rings, hooks, karabiners) must be capable of supporting at least 5000 lbs. (23 kN). Do not use equipment that is not compatible. Non-compatible connectors may unintentionally disengage. Self-locking snap hooks and Karabiners are required by CSA, ANSI and OSHA. Connectors must be compatible in size, shape, and strength.
- ✎ **Making Connections:** Only use self-locking snap hooks and Karabiners with any SAFEKEEPER Fall Protection equipment. Do not use equipment that is not compatible.

Ÿ **TRAINING:**

It is the responsibility of the users to ensure that they read, understand, and follow all instructions and are trained in the care and use of this device. Training should be repeated periodically and any time there is a change of components within the system. Training must be conducted without exposing the trainee to a fall hazard.

Ÿ **As Per OSHA:** Anchorages used for attachment of personal fall arrest systems shall be independent of any anchorage being used to support or suspend platforms and capable of supporting at least 5,000 lbs. (23kN) per user attached, or be designed, installed and used as part of a complete PFAS which maintains a safety factor of at least two, and is under the supervision of a qualified person.

17. **OTHERS:**

Ÿ **MAINTENANCE & CLEANING:**

Repairs to equipment can be made only by a SAFEKEEPER representative or person or entity authorized by SAFEKEEPER. Contact SAFEKEEPER for maintenance and repair. Cleaning after use is important for maintaining the safety and life of the equipment. Cleanse the equipment of all dirt, corrosives, and contaminants. If the equipment cannot simply be wiped clean, use a mild soap and water. Rinse, wipe, and hang to dry in shade.

Ÿ **STORAGE:**

Store the anchorage connector component in a cool, dry and clean place out of direct sunlight. Avoid areas where heat, moisture, light, oil, and chemicals or their vapors or other degrading elements may be present. Equipment which is damaged or in need of maintenance should not be stored in the same area as usable equipment. Heavily soiled, wet, or otherwise contaminated equipment should be properly maintained (e.g. dried and cleaned) prior to storage.

Prior to using equipment which has been stored for long periods of time, a Formal Inspection should be performed by a competent person. For harnesses with Dielectric buckles, pass-thru buckles or Quick Connect Buckles, store the harness with the buckles connected.



18. MARKINGS:



II 2G  
Ex II C T6 Gb



*Safe Keeper*  
**Beam Anchor**  
**Ref.: SA08-SK**



Read the user instructions carefully before each use.

Serial No.: XXXXX      Batch No.: XXXXX

Minimum Breaking Strength: 23kN (5000lbs)

Service Temperature: -30°F to 130°F (-34°C to 54°C)

Complies with EN 795:2012 Type B & ANSI Z359.18-2017 Type A

**DOM:**

MAX



**SPECIFICATIONS:** Maximum Capacity is one person with a maximum weight of 140kg (310lbs) , when used as a single point anchor connector for a personal fall arrest or restraint system.

Flange Width: 3.54" - 13.4" (90mm - 340mm)

**MATERIALS OF CONSTRUCTION:** Locking beam - High Strength Aluminum Alloy, Roller - High Strength Aluminum Alloy, D-Ring - Alloy Steel, Flange- Locking pin - Stainless Steel.

**⚠ WARNING:**

Read carefully the manufacturer's instructions provided with this product at the time of shipment for proper use, maintenance and inspection. Use only with ANSI/OSHA compliant personal fall arrest or restraint systems. Ensure fixed beam anchor is adjusted tightly on beam flange. Make only compatible connection. Any alteration, misuse or failure to follow instructions may result in serious injury or death.

**ANY ALTERATION, ABUSE OR MISUSE OF THIS PRODUCT VOIDS THE WARRANTY.**

**DO NOT REMOVE THIS LABEL.**

**Inspection Grid**

Made In India

Y	R	M	J	F	M	A	M	J	J	A	S	O	N	D
20														
20														
20														
20														
20														
20														
20														
20														
20														
20														

**Inspection-** Before every use, user must inspect the product. Every 6 months a competent person must complete final inspection of the product and record initials.







SAFE KEEPER, 314 E. CANAL ST. MULBERRY, FL 33860

---